



Data Sheet *HISbasic*
HIS550R-OWC
TO-39/TO-5 Thermal Infrared Emitter

HIS550R-OWC

Thermal infrared emitter with gold plated reflector and Winston cone collimator

Our HIS550R-OWC is a NiCr filament based thermal emitter in a TO39 package, with a gold plated reflector as well as a gold plated Winston cone collimator. While the reflector directs the radiation emitted from the rear of the filament to the front, the Winston cone collimator bundles the beam for maximum optical output power. The open emitter offers high performance for a wide spectral measuring range.

HISbasic series emitters have an integrated gold plated reflector that directs the radiation emitted from the rear to the front in order to achieve maximum efficiency. All our emitters offer minimum drift at constant resistance (Ohm). Infrasolids IR emitters are characterized by a very low temperature coefficient of electrical resistance. Therefore the hot resistance and the cold resistance are almost identical which eases the electrical control of the IR sources.

Key features

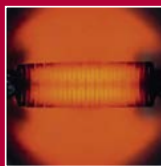

**High radiant
power**

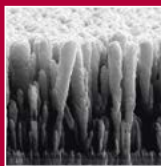

**High
efficiency**



**Low
cost**

- ✓ Pulsable thermal black-body infrared source mounted in an industry standard TO-39/TO-5 package.
- ✓ Patented nanostructured radiating element achieves up to 500% more detection signal!
- ✓ Lower radiating element temperature of 600 °C increases lifetime!
- ✓ Wide wavelength range enables a broad range of applications.

*innovative infrared sources for
gas detection & spectroscopy*

Main specifications

Parameter	HIS550R-OWC
Package	TO-39 / TO-5
Radiating element area	11 mm ²
Radiating element emissivity	> 0.9
Radiating element temperature	600 °C at 650 mW
Optical output power	up to 215 mW
Max. electrical power (DC)	700 mW
Max. electrical voltage	4.0 V
Max. electrical current	175 mA
Electrical resistance	21...23 Ω
Modulation frequency*	6 Hz
Wavelength range	2 to 20 μm

* 50 % modulation depth, square wave signal, 50 % duty cycle

Optical specifications

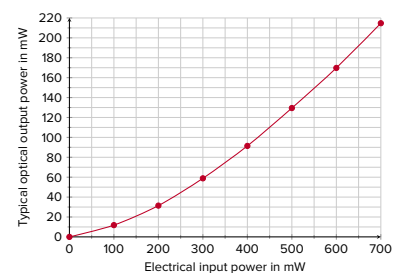
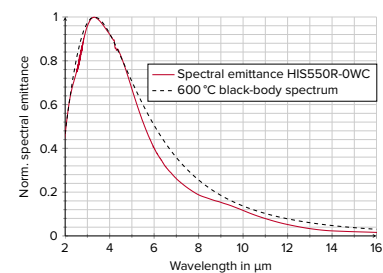

Radiating element temperature

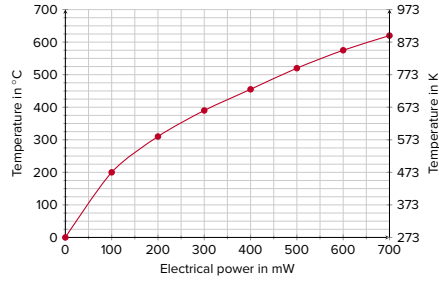

Modulation depth

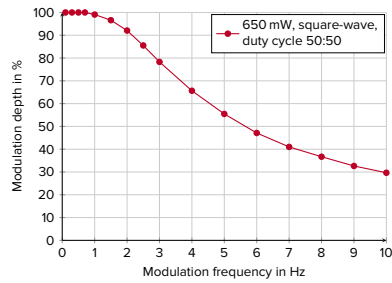

Electrical specifications

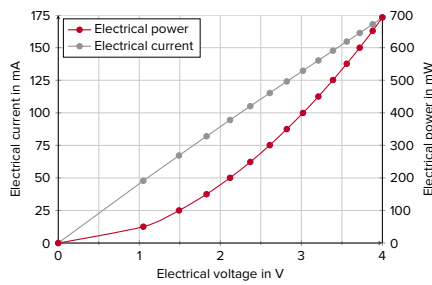

HIS550R-0WC

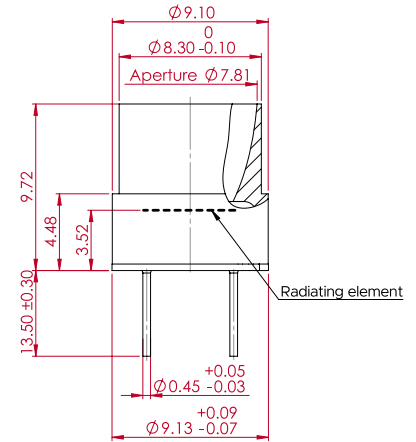
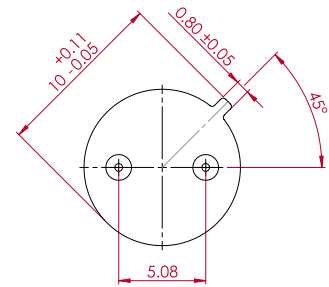

Angular radiation distribution (without window)

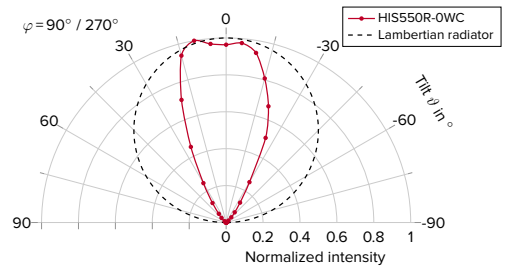
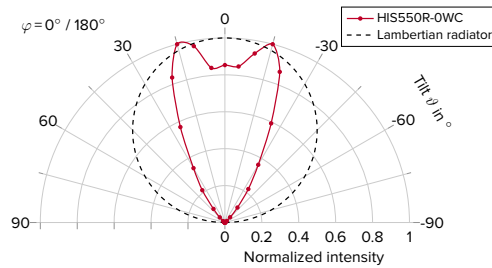
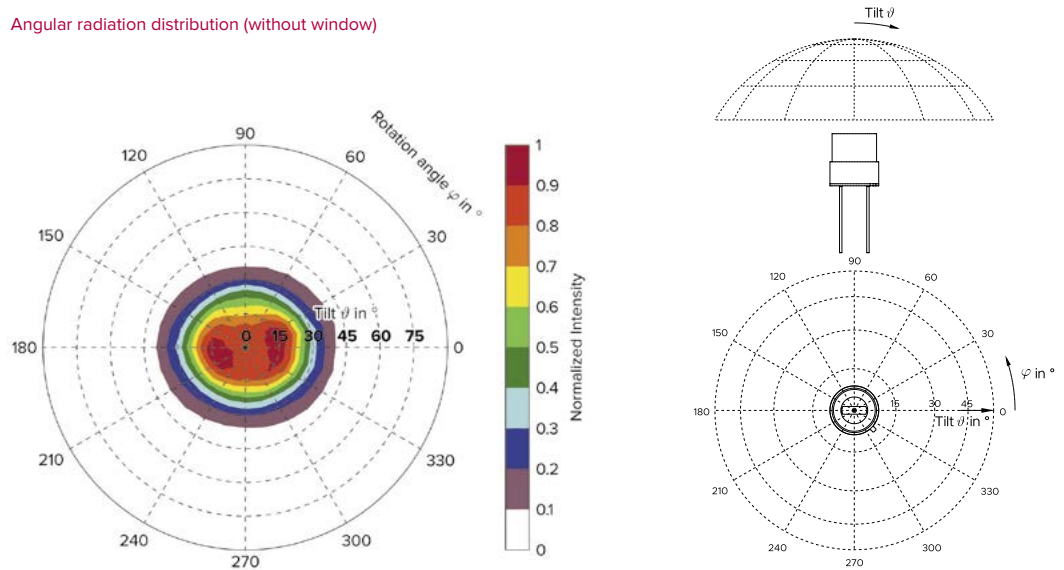

Operating mode recommendation:

All our IR sources can be driven in electrical voltage, current or power regulated mode. The application decides whether the operating mode is DC or AC (pulsed). Depending on the drive mode and the applied electrical power the electrical resistance of the IR emitter can change over time. For highest measurement accuracy a power regulated mode is always recommended for thermal IR emitters. However, it is the most complex operating mode and not suitable in all applications.

For applications that require a small and low-cost driving circuit with a maximum stability we have a technical note with an adjustable low dropout voltage (LDO) regulator.

For further information please refer to: www.infrasolid.com/technicalnote